



Charleston wandmodel met RF-bediening



Charleston plintmodel met RF-bediening

- **Type:** kolomradiator
- **Buizen:** ronde verticale buizen, diam. 25 mm, met 3 of 5 kolommen
- **Afwerking:** standaardkleur wit RAL 9016
- **Bevestigingen:** type NZ 030-100: incl. 2 aangelaste verstelbare voeten in kleur van de radiator
type NZ 060-XXX : incl. 2 bijgeleverde muurbevestigingen in kleur radiator, met vergrendeling

Elektrische versie

- Gevuld met thermogeleidende en hoge weerstandbiedende minerale olie
- Ingebouwd elektrisch verwarmingspatroon
- Met RF-bediening
- Geleverd zonder stekker
- Details bediening
- Normalisatie: klasse II – IP 34 – IK09 - CE



RF-bediening

Opties

- Kleurenkaart
- Aparte steunvoeten
- Reinigingsborstel van schapenvacht voor eenvoudige reiniging



reinigingsborstel van schapenvacht

Technische gegevens

Modeloverzicht

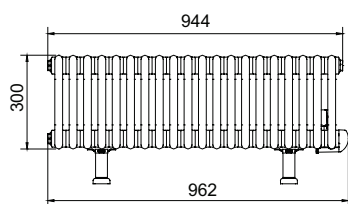

NZ-030-100/GF

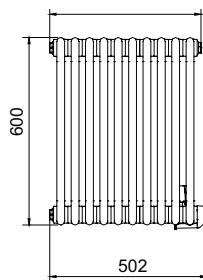

NZ-060-053/GF

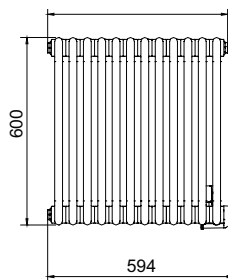

NZ-060-062/GF

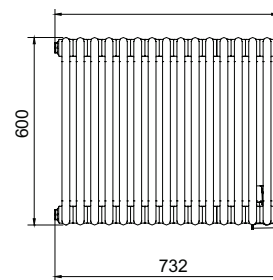

NZ-060-076/GF

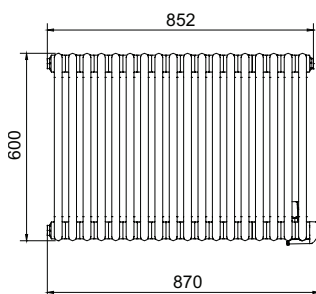

NZ-060-089/GF

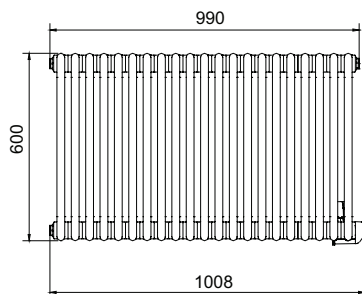

NZ-060-103/GF

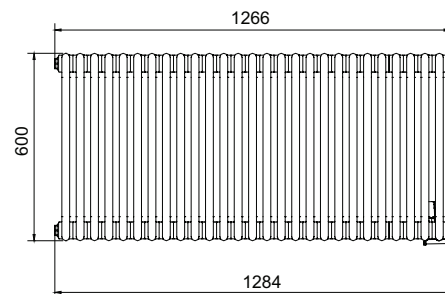

NZ-060-131/GF

Elektrische versie, wandmodel met RF-bediening
Gelakte uitvoering

Model	H mm	L mm	Elektr. vermogen Watt	Gewicht kg
NZ-060-053/GF	613	502	500	27
NZ-060-062/GF	613	594	750	30
NZ-060-076/GF	613	732	1000	41
NZ-060-089/GF	613	870	1250	47
NZ-060-103/GF	613	1008	1500	58
NZ-060-131/GF	613	1282	2000	70

H = Bouwhoogte inclusief bediening / L = Bouwlengte inclusief bediening

Elektrische versie, plintmodel met RF-bediening
Gelakte uitvoering

Model	H mm	L mm	Elektr. vermogen Watt	Gewicht kg
NZ-030-100/GF	300	962	1000	42,4

Type NZ + voet van 110 mm

* = Warmtevermogen gemeten volgens EN 442, Δ T 50 K

Zehnder Charleston

Technische tekeningen

Elektrische versie
Wandmodel - 3 kolom

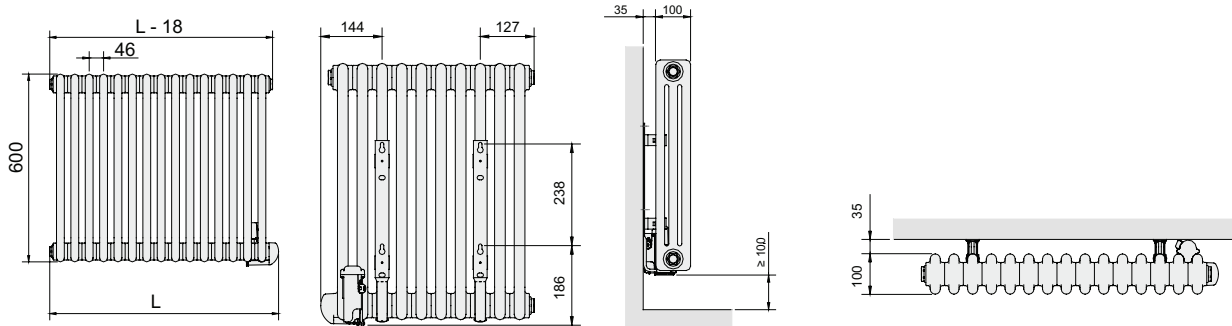

Elektrische versie
Plintmodel - 5 kolom

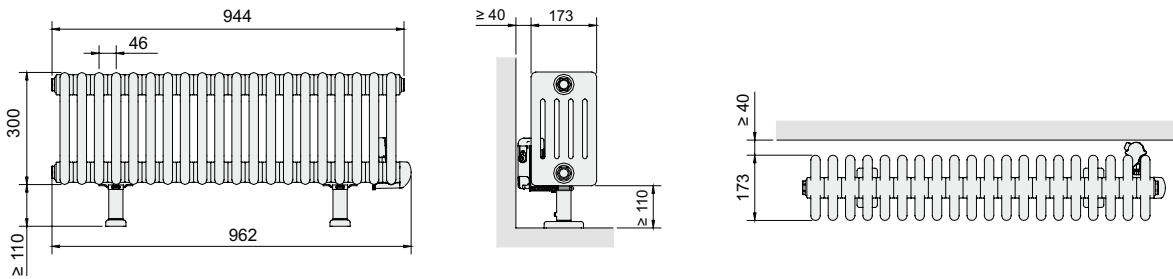

Afmetingen in mm